



Clothes Dryer Duct Booster® Reference Guide

Booster Fans and Accessories for Residential and Commercial Clothes Dryers



Model LB2

Dryer Duct Booster for residential capacity clothes dryers (160 CFM)



Model CDB8

Indoor mount commercial dryer Duct Booster for up to 4 laundromat capacity dryers (up to 1000 CFM)



Models RT750 and RT1500

Roof mount commercial dryer Duct Boosters for up to 6 laundromat capacity dryers (up to 750 or 1500 CFM)

Inadequate exhaust velocity is the source of three major problems:

- ◆ Excessive lint build-up within the dryer and duct that adds progressively more air flow resistance & creates a potential fire hazard.
- ◆ Inflated utility bills due to excessively long drying times.
- ◆ Extended drying times causing users to wait up to 50% longer than necessary for loads to dry.

LB2 Dryer Duct Booster for Residential Electric and Gas Clothes Dryers

Meets UL 705 DEDPV Requirements / Complies with IRC-2015

- ▶ Duct lengths are commonly stated in equivalent feet. Most residential clothes dryers are rated for a maximum exhaust duct length of 25 equivalent feet. At 25 equivalent feet or less the dryer's blower can maintain a proper exhaust velocity to efficiently dry the load of clothing and exhaust lint to the outdoors.
- ▶ With 4 inch duct, 90 degree elbows are equivalent to 5 feet of straight duct resistance. Three elbows and 10 feet of straight duct are equal to the 25 equivalent foot limit, so it is very easy to exceed the maximum duct length.

- ▶ Elbows connected to elbows chokes exhaust flow.
- ▶ Gravity fights moist, lint-laden exhaust in vertically run, roof terminated ducts.

Give your dryer duct a boost by adding a Tjernlund LB2

- ▶ Reduce lint build-up and duct cleaning.
- ▶ Save energy, reduce drying times by up to 50%.
- ▶ Boost exhaust velocity in ducts up to 150 equivalent feet long.



Typical Laundry Room Installation



Typical Closet Installation

Designed to provide years of reliable performance

On-board multi-functional control

Install and plug-in. Pressure and temperature sensors self calibrate to automatically sync the Booster Fan operation with your clothes dryer operation.

Status Panel confirms proper Booster Fan operation while the dryer is running and alerts user to duct blockage, fan failure and excessive exhaust temperatures. The Booster Fan will deactivate if excessive temperatures are detected.

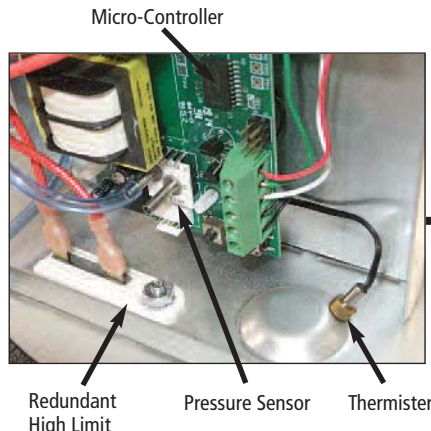

PSC permanently lubricated ball bearing motor is not exposed to heat, lint or moisture. Uses less power than a 50 watt light bulb.

Rubber isolated mounting bracket eliminates vibration transfer. Rotates 360° to accommodate any mounting orientation.

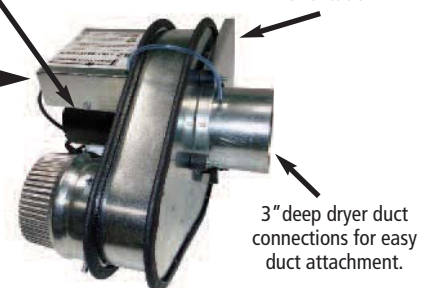

For best performance install the LB2 Booster Fan as directed below

Total Duct Length Equivalent Feet*	LB2 Minimum Distance from Dryer in Equivalent Feet*	
	No Secondary Lint Trap	With Secondary Lint Trap 4' from Dryer**
30	15	8
60	30	8
90	35	15
120	40	20
150	45	25

Install Booster Fan no closer than 2 feet from exterior hood.

*Equivalent feet equals linear feet plus 5 additional feet for each 90° elbow and 2.5 feet for each 45° elbow (assumes 4" diameter duct).

**Use Tjernlund model LT4 Secondary Lint Trap.

Suggested duct layouts for restricted spaces

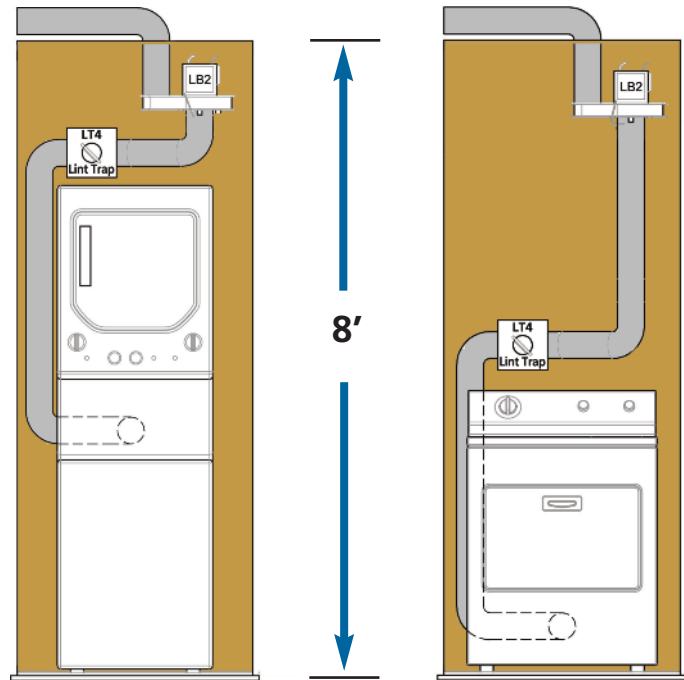

See why the LB2 Lint Blitzer™ blower wheel has a 5-year no-clog guarantee

Go to www.dryerboosters.com to see for yourself how our Dryer Duct Booster outperforms typical in-line fans in a lint build-up test.

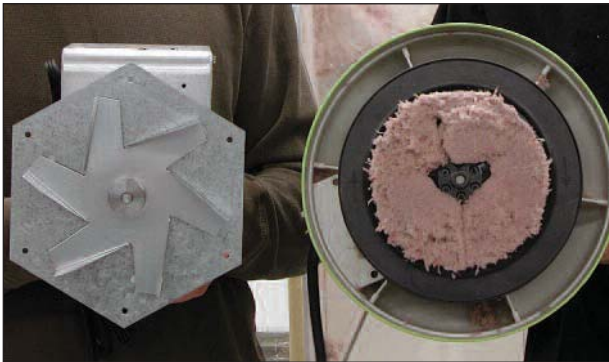

Dimensions

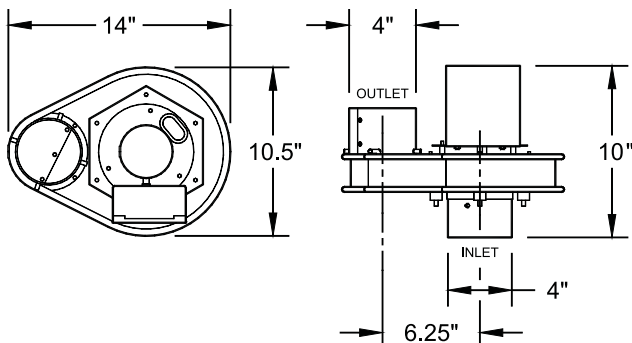

Dryer Duct Booster® fans can be installed horizontally or vertically. Vibration isolated mounting bracket securely holds fan while reducing noise transfer.



Horizontally Mounted



Vertically Mounted

Specifications

Model	Voltage	Watts	Amps	CFM
LB2	120 VAC	50	0.5	160



Modulating Dryer Duct Boosters for Laundromats and Laundry Rooms

- ▶ Commercial clothes dryers work best when they are ducted individually to the outdoors. For facilities with many dryers this means multiple holes cut through the wall or roof which is expensive initially and creates many potential points of moisture entry into the building envelope.
- ▶ One solution is to exhaust multiple dryers into a single duct and termination. But this solves one problem and creates another. Depending on the number of dryers operating there will be wide swings in the exhaust velocity, reducing dryer efficiency and causing excessive lint formation in the ducts and facility.
- ▶ Our COP-Series controllers measure pressure within the common duct and modulate our Commercial Dryer Duct Booster fans to match exhaust volume changes. This helps each dryer operate more efficiently and keeps lint suspended within the duct until it is exhausted outdoors.



All Tjernlund Dryer Duct Boosters feature material handling blower wheels to eliminate lint buildup within the blower housing, reducing maintenance to a minimum.

CDB8 Indoor Mount Booster Fan



With IEK8 In-Line Elbow Kit installer can keep exhaust vent on a straight line.

RT750 and RT1500 Rooftop Exhaust Fans



Clamshell design allows easy access for inspection of duct and blower wheel.

Selecting the proper commercial Dryer Duct Booster duct size

Dryers operate most efficiently when exhaust velocities between 1200-2200 feet-per-minute (FPM) are maintained. The number of co-ducted dryers operating, exhaust fan model selection and the diameter and length of the common exhaust duct can dramatically affect exhaust velocity. Follow the recommendations below to maximize the efficiency of the Tjernlund exhaust system and connected dryers.

Over sizing the exhaust manifold will reduce velocities and allow more opportunity for lint to drop out of the exhaust stream. Undersized or excessively long exhaust manifolds will increase drying time and operating costs. COP controller set point adjustments will allow velocities to be fine tuned.

Common exhaust manifold sizing and Dryer Booster Fan selection

1. Based on the CFM total for all connected dryers find the Total Dryer CFM value in the left column of the table equal to or greater than that CFM and determine the common manifold **minimum or maximum** duct diameter.

2. Trace to the right to select the Dryer Booster and determine the maximum equivalent length of common duct based upon your choice of either the minimum or maximum duct diameter.

Example: 4 Dryers @ 225 CFM/ea.

4 x 225 = 900 Total Dryer CFM

Minimum duct diameter at 900 CFM is 9 inches

Maximum duct diameter at 900 CFM is 12 inches

Installing a common duct sized between 9" and 12" is the optimal size range for maintaining a proper velocity across all operating conditions. Trace to the right to select the Dryer Booster and maximum equivalent feet of common duct based on your duct diameter choice.

Commercial Dryer Booster Selection and Duct Sizing Table

Total Dryer CFM	Common Manifold Minimum Duct Dia.	Common Manifold Maximum Duct Dia.	Rooftop Mount Series	Max. Equivalent Feet @ Min. Duct Diameter	Max Equivalent Feet @ Max. Duct Diameter	Indoor Mount CDB8	Max Equivalent Feet @ Min. Duct Diameter	Max Equivalent Feet @ Max. Duct Diameter
400	6"	8"	RT750	50	200	CDB8	120	200
500	7"	9"	RT750	50	150	CDB8	160	200
600	8"	10"	RT750	50	150	CDB8	165	200
700	8"	10"	RT750	NA	50	CDB8	100	200
800	9"	10"	RT1500	150	200	CDB8	100	150
900	9"	12"	RT1500	50	200	CDB8	30	125
1000	10"	12"	RT1500	100	200	CDB8	15	30
1100	10"	12"	RT1500	75	200	CDB8	NA	NA
1200	10"	14"	RT1500	50	200	NA	NA	NA
1300	10"	14"	RT1500	50	200	NA	NA	NA
1400	12"	14"	RT1500	75	150	NA	NA	NA
1500	12"	14"	RT1500	50	150	NA	NA	NA

Contact Tjernlund Tech Service for advice on applications outside the boundaries of this table.

Important Common Manifold Construction Recommendations

Always install a capped length of straight pipe at least 1 pipe diameter long behind the dryer farthest from the exhaust termination for a stable place to measure exhaust pressure.

Always connect individual dryers to the common manifold using wye connectors pointed towards the exhaust termination. Do not use straight tee connections.

Dryer Booster System Component Selection

BOOSTER MODEL	CONTROLS	REQUIRED ACCESSORIES	OPTIONAL ACCESSORIES
CDB8 Indoor Mount Booster Fan	COP2DB Control	N/A	IEK8 In-Line Elbow Kit DEVH8 or DEVH12 Vent Hood
RT750 Rooftop Exhaust Fan	COP2 Control	DH750 Discharge Hood with Gravity Damper	RTS8 Rooftop Stand
RT1500 Rooftop Exhaust Fan	COP2 Control	DH1500 Discharge Hood with Gravity Damper	RTS12 Rooftop Stand

CDB8 Indoor Mount Booster Fan

For both wall and roof terminated dryer exhaust. Features temp activated motor cooling fan and material handling blower wheel. 8" inlet/outlet connections. 120 volt / 6.2 Amps.



COP2DB Pressure Control

Modulates fan to maintain desired exhaust pressure set point. Input Power: 115 VAC ±10%, 47-64 Hz. Single Phase, 6.2 Amps. Output Power: 115 VAC, 6-70 Hz. Single Phase. **For use only with model CDB8 Booster Fan.**

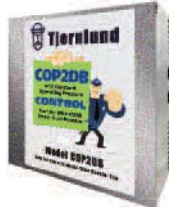

DEVH8 (8") and DEVH12 (12") Vent Hoods

G90 galvanized steel commercial dryer exhaust hoods with internal gravity flapper. 8" or 12" duct connectors. Select size equal to or greater than common manifold diameter.



IEK8 In-Line Elbow Kit

Allows CDB8 to be installed in-line, maintaining a straight line exhaust duct. Replaces 42" section of straight duct. Includes two sweep elbows and one 12" section of 8" diameter duct. Use tapered transitions prior to & after elbows if duct size of manifold is larger.



RT750 Rooftop Exhaust Fan

Features temp activated motor cooling fan and stainless steel, material handling blower wheel. 8" inlet connection. 120 volt / 1.2 amp. Requires DH750 Discharge Hoods for dryer exhaust applications.



RT1500 Rooftop Exhaust Fan

Features temp activated motor cooling fan and stainless steel material handling blower wheel. 12" inlet connection. 120 volt / 6.2 Amps. Requires DH1500 Discharge Hoods for dryer exhaust applications.



COP2 Pressure Control

Modulates fan to maintain desired exhaust pressure set point. Input Power: 115 VAC ±10%, 47-64 Hz. Single Phase, 6.2 Amps. Output Power: 115 VAC, 6-70 Hz. Single Phase. **For use only with model RT750 & RT1500 Exhaust Fans.**



DH750 & DH1500 Discharge Hoods

Replaces standard discharge grilles on RT-Series fans. Kit includes two hoods with built-in gravity flapper.



RTS8 (RT750-Series) or RTS12 (RT1500-Series) Rooftop Stands

Supports inducer and adjusts from 10" to 16" from inducer inlet to the roof surface. **For flat roofs only.**



RT Series Dimensions

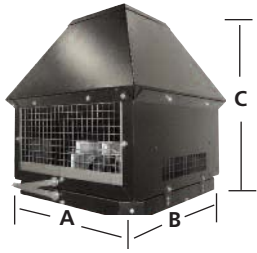

Model	RT750(H)	RT1500(H)
A	14.5"	17"
B	14.5"	17"
C	17.5"	22.5"
Inlet	8"	12"

Specifications

Model	RT750(H)	RT1500(H)
Motor HP	1/12	1/2
Motor Amps	1.2	6.2
Motor Volts	120	120
Ship Weight	54 lbs	74 lbs



ETL Listed to UL378, UL705
& CAN/CSA B255-M81

CDB8 Dimensions

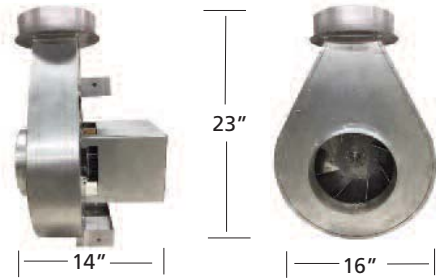

Specifications

Model	CDB8
Motor HP	1/2
Motor Amps	6.2
Motor Volts	120
Ship Weight	40 lbs

Typical common exhaust duct layouts for multiple clothes dryers using Tjernlund Commercial Booster Fans

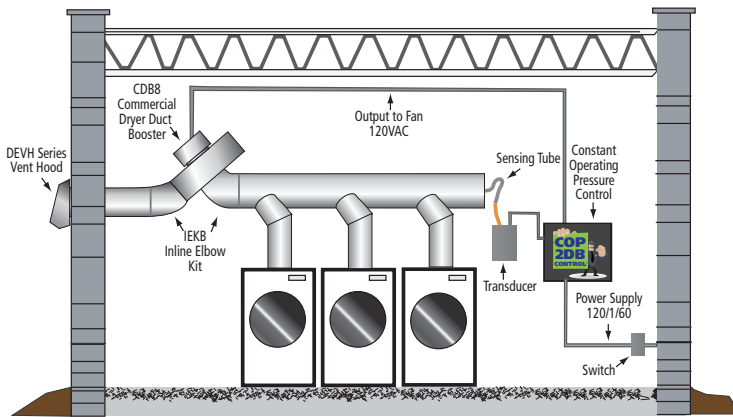

CDB8 indoor mount Booster with side wall termination

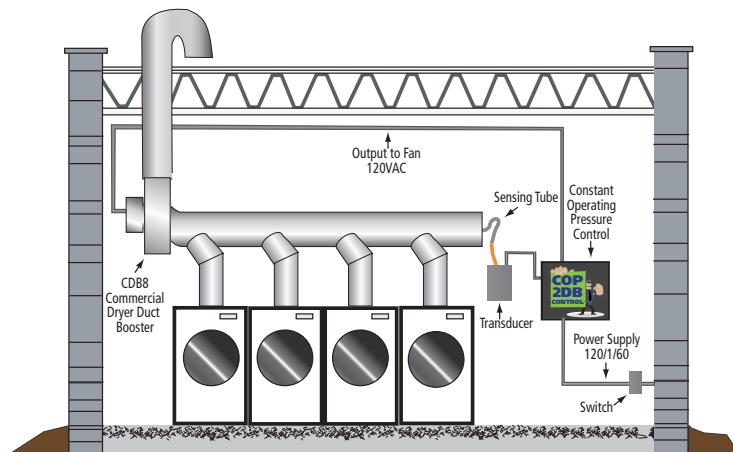

CDB8 indoor mount Booster with roof termination

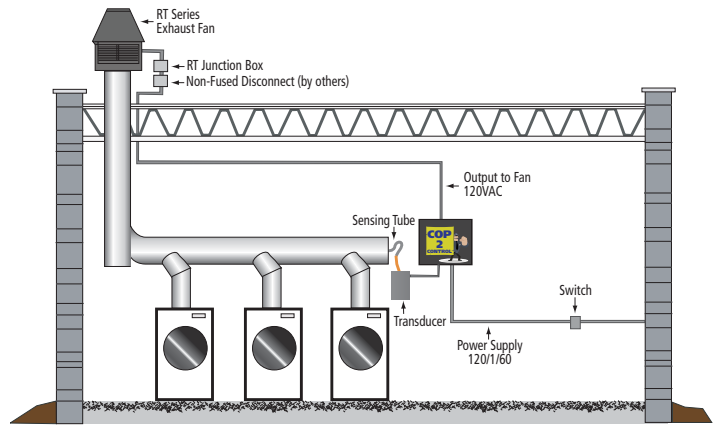

RT Series Exhaust Fan with multi-dryer common vent

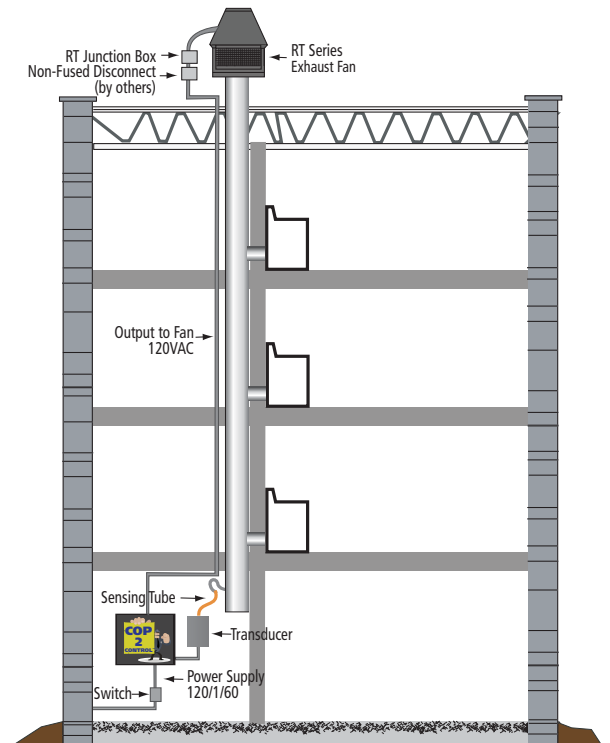

RT Series Exhaust Fan for multi-story chase

Specified Dryer Exhaust and Make-up Air Systems for large commercial laundries and multi-story chases

Tjernlund Specified Systems include a wide range of exhaust and make-up air fans and blowers. Pair with a matching VFD and the CPC-3 Controller to create a demand-based variable speed system that matches your exhaust and/or make-up air needs.

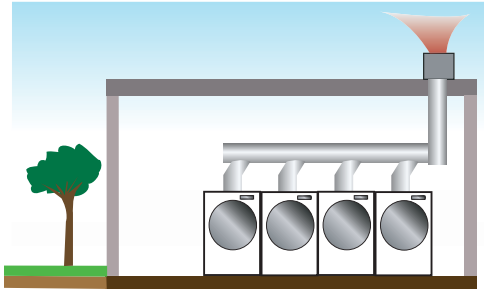

Commercial Dryer Exhaust

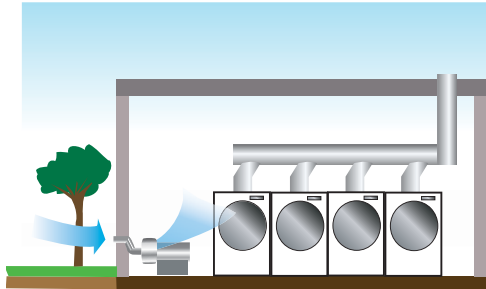

Commercial Dryer Make-Up Air

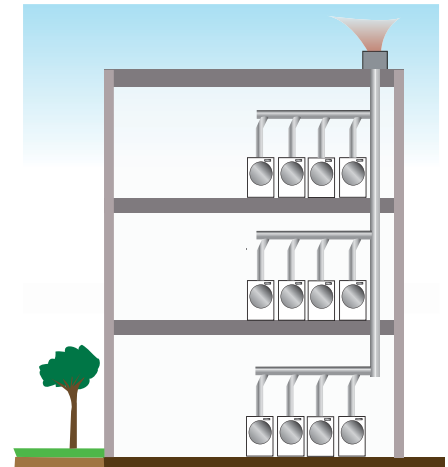

Central Exhaust Vent System
Serving Multiple Clothes Dryers

VSAD-Series Rooftop or Wall Mount Exhaust Fans

Models available from 1500 to 2800 CFM

All models feature a Ryton PPS coated 5052 aluminum clamshell housing and backward inclined stainless steel blower wheel. All models include weather proof junction box with 4' whip and fan proving switch. Optional roof stands and wall mounting kits.



VSUB-Series Indoor/Outdoor Universal Supply/Exhaust Blowers

Models available from 800 to 5500 CFM

All models feature 14 gauge, 316L stainless steel housings that rotate 180° for installation flexibility. All have a backward inclined, high temp coated class 1 blower wheel. All include a weatherproof j-box with 4' whip, rectangular to round outlet pipe adapter, fan proving switch and condensate drain kit.



VSVS-Series Variable Speed Exhausters

Models available from 3,000 to 16,000 CFM

All models have continuously welded; polyester powder coated housings and backward inclined aluminum blower wheels. For indoor or outdoor installation. Fan proving switch included.

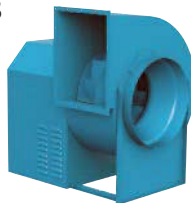

VSRI-Series Round, In-line Make-up Air or Ventilation Fans

Models available from 500 to 25,000 CFM

All models feature continuously welded, enamel coated housings. Internal motor with non-overloading aluminum impeller. Weatherproof junction box, fan proving switch and hi/low ambient limit included.



CPC-3 Constant Pressure Controller

For All Specified Systems Fans and Exhausters

Two channel controller independently monitors exhaust and room pressure and modulates fans via a matched VFD to maintain pressure settings. Program options include exhaust pressure set point, make-up air pressure set point, pre and post purge, motorized louver interface and manual or automatic operation.



TD-Series Pressure Transducers

Self calibrating pressure transducers accurately measure pressure. Choose TD-2 for exhaust pressure or TD-3 for room pressure make-up air monitoring.



VFD-Series Variable Frequency Motor Drives

Factory programmed to match specific Tjernlund Specified Systems fans and blowers. Closed loop models pair with CPC-3 controller for automatic motor speed control, open loop models allow for manual adjustment of motor speed without a CPC-3 Controller. Specify supply power voltage when ordering.



Contact Tjernlund Products tech service for application and products selection assistance. Tjernlund Specified Systems are available through location specific Sales Rep Agencies in the U.S and Canada.

Available From:



TJERNLUND PRODUCTS, INC.

1601 Ninth Street White Bear Lake, MN 55110-6794
Phone: 651.426.2993 800.255.4208 Fax: 651.426.9547
Visit our web site: tjernlund.com email: fanmail@tjfans.com
Copyright © 2017 Tjernlund Products, Inc. All rights reserved. P/N 8500303