

✓Residential ✓Commercial ✓Industrial

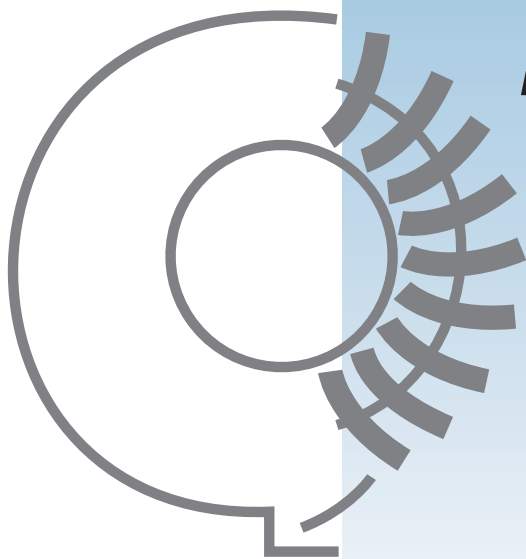

# *In-Line Draft Inducers*



by

**Tjernlund**

# Reference Guide

## **Improve Heating Efficiency**

In-Line Draft Inducers assure positive draft when restricted boilers and furnaces, poor chimneys or negative pressures in buildings prevent proper exhaust of combustion gases. The Venturi action starts air moving up the stack instantly and keeps it moving smoothly. In-Line inducers are built for long-lasting, trouble-free service and available in sizes and capacities to meet virtually all heating system requirements. The Vari-Draft control permits adjustment to individual job requirements. Vents/Chimneys utilizing In-Line Draft Inducers must be vertically terminated above the roof line.

## **Typical Applications:**

- Boilers/Furnaces
- Water Heaters
- Modular Boiler Systems
- Multiple Appliances
- Bakery Ovens
- Factory Processes

## **Solves Venting Problems:**

- Undersized Chimneys
- Negative Pressures
- Long Horizontal Vent Connectors
- Down Drafts
- Cold Equipment Starts
- Restrictive Heat Exchangers/Combustion Chambers

**Use On Vertically Terminated Vent Systems Only**

[www.tjernlund.com](http://www.tjernlund.com) • 800.255.4208

# A Size For Every Application

Tjernlund offers six In-Line Draft Inducers to fit vent pipe sizes from 3" to 24".

Models DJ-3, D-3

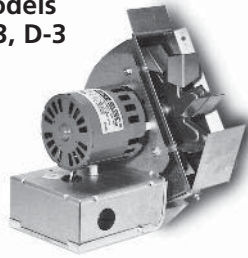

Models I, IL, XL

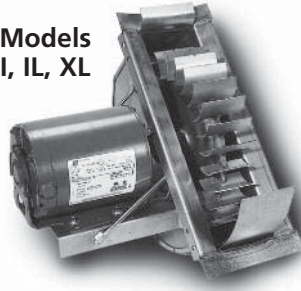

Model HD

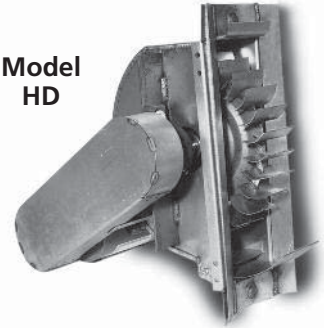

## Easy Installation

Three Basic Steps...

### 1. Cut Slot in Pipe



### 2. Insert Inducer

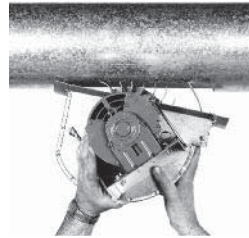

### 3. Install Bands\*

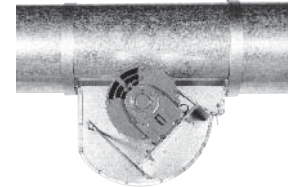

\* Models DJ-3 & D-3 fasten with screws.

- Select a position between draft hood, diverter or barometric damper and chimney, locating the Inducer as close to the chimney as possible. Inducer should be mounted 2-3 pipe diameters away from a directional change, i.e. elbows and tees, so turbulence is not created.

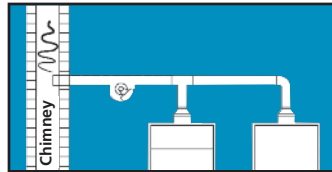

- Mount the Draft Inducer on vertical, horizontal or inclined vent pipe. If used on a horizontal vent pipe, mount Inducer on bottom of pipe, not on top, to avoid creating a heat trap in the Inducer.
- The motor shaft must be level and horizontal to avoid excessive wear on bearing.

- If change in vent pipe size is required, use a tapered increaser or reducer.
- In-Line Inducers should be installed on a section of single wall vent pipe in order to assure proper performance.
- Do not use In-Line Draft Inducers on condensing heating equipment.
- We recommend the use of a carbon monoxide detector in all mechanical rooms.

## Everything Needed to Conform with National Mechanical Codes

### Fan Prover Safety Interlock Model PS1505

To satisfy national mechanical codes for oil and gas installations, Draft Inducers must be properly interlocked with burner circuits. The PS1505 Fan Proving Switch monitors pressure within the Inducer housing to verify Inducer operation. Used in conjunction with the UC1 Universal Control, it assures compliance with codes and simplifies electrical interlock with all 24/115 VAC burner circuits. The PS1505 is not compatible with millivolt gas valves.

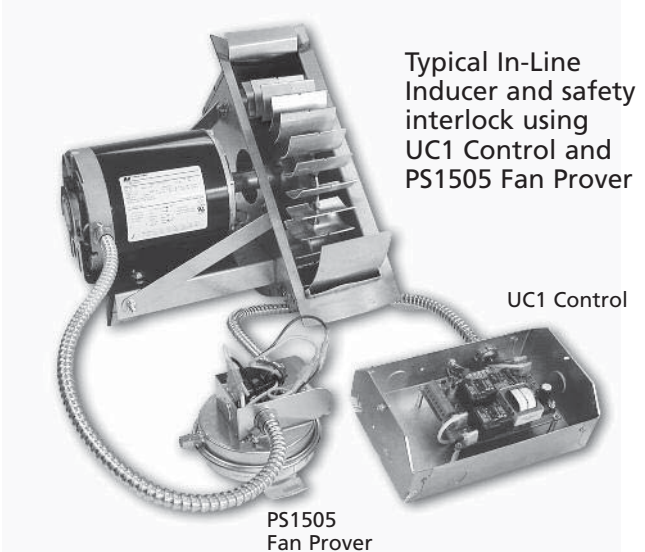
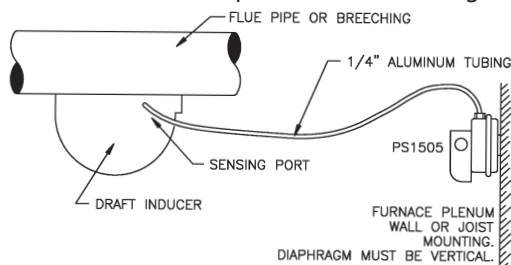

Typical In-Line Inducer and safety interlock using UC1 Control and PS1505 Fan Prover

UC1 Control

PS1505 Fan Prover

# Accessories

*The UC1 is a standardized control for Tjernlund Inducers/Venters. It offers many installation, operational and safety benefits.*

## Universal Control Model UC1

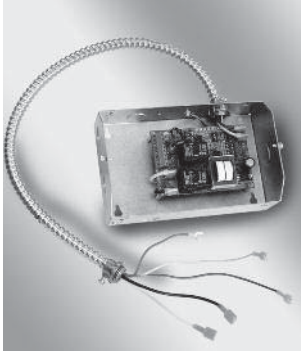

Solid state control interlocks with virtually any burner control circuit. Features include: adjustable pre and post purge, LED status/diagnostic indicators, prover switch delay to avoid burner start up and wind induced short cycling. Interlocks with any 24/115 VAC burner control circuit and also includes "dry" contact actuation option. Selectable voltage eliminates false activation by burner control check circuits.

For additional information request brochure #8500004

## Multiple Appliance Controls Models MAC1E, MAC4E

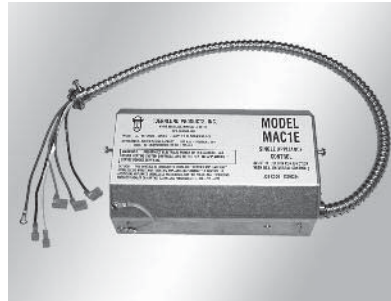

Used with any UC1 controlled Inducer to interlock additional 24/115 VAC heaters. Powered by and communicates with the UC1 through a factory wired whip. For one additional 24/115 VAC heater add the MAC1E. To interlock up to four more additional 24/115 VAC heaters, add the MAC4E. MAC4Es can be

daisy chained together for greater than 5 heaters. **Important:** Total combined BTU/hr. input of all heaters and total equivalent pipe lengths must be within Inducer's capacity.

## Millivolt Safety Interlock Kit Model WHKE



For use with UC1 Universal Control, MAC1E or MAC4E auxiliary controls. The WHKE gas pressure switch actuates the Inducer through the A - B dry contacts. The Linear Limit switch disables the heater in the event of a venting malfunction. Includes JA1 thermocouple junction adapter. To interlock millivolt water heater(s) only with a UC1 controlled Inducer add a

WHKE for each millivolt heater. To interlock a millivolt water heater and one 24/115 VAC furnace or boiler with a UC1 controlled Inducer, add a WHKE and a MAC1E.

## Barometric Draft Controls

Models DC4, DC5, DC6, DC7, DC8, DC9, DC10  
DC4G, DC6G, DC7G, DC8G, DC9G, DC10G



Quality engineered and manufactured to maintain a consistent draft on a wide range of oil and gas fired heating equipment. May be used with chimney vented or power vented heating equipment. For fan assisted gas, oil or solid fuel applications with vent diameters from 4"-10", choose the DC4 thru DC10.

For LP and natural gas applications with vent diameters from 4"-10", choose the DC4G thru DC10G.

For additional information request brochure #8500490

# Model Dimensions

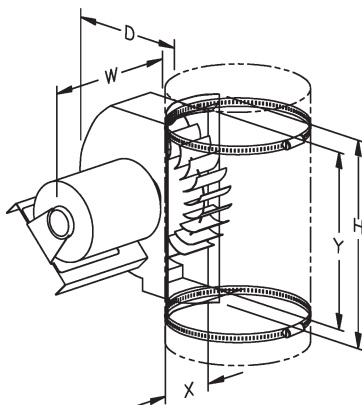

"H" — Overall Height  
"D" — Overall Depth  
"W" — Overall Width  
"X" — Pipe Slot Width  
"Y" — Pipe Slot Height

Model	Unit Dimensions (In.)			Slot		Ship Weight
	H	W	D	X	Y	
DJ-3	7 1/2	8 1/2	5 7/8	2 5/8	7 5/8	8 Lbs
D-3	9 1/8	9 1/2	7	3 1/8	8 5/8	10 Lbs
I	14 1/2	13 1/2	8 3/4	4	12 3/4	31 Lbs
IL	17	14 3/4	10	4 1/8	15	34 Lbs
XL	18 7/8	18 1/2	10 1/2	5 1/8	16 3/4	53 Lbs
HD	27 1/2	16 3/4	25	6	24 1/2	176 Lbs

# Model Selection Table and Electrical Data

1. Inputs shown are believed to be maximum capacities for inducers when mounted on pipe sizes shown for ordinary jobs where a moderate amount of mechanical induced draft is required.

2. Consideration is given to typically higher static pressure requirements for larger installations, for the type of fuel burned and for the type of draft control installed.

3. Some ratings may only be valid for extremely short vent lengths due to excessive pressure loss; i.e. the Model IL gas firing with draft hood in 10" pipe at 2,080,000 BTU/hr.

4. Where pressure requirements are unknown or believed to be unusually severe, ask for complete performance curves or consult factory.

5. Draft Inducers should be installed in single wall vent pipe in order to assure proper performance.

Note: Tjernlund Products Inc. reserves the right to make changes to specifications without notice.

Model	Pipe Size In.	Gas Firing with Draft Hood			Gas Firing with Barometric Draft Control			Oil Firing with Barometric Draft Control			Electrical Specifications					
		Heater BTU Input	270°F Flue Gas		Heater BTU Input	390°F Flue Gas		Heater BTU Input	530°F Flue Gas		Volts	HZ	RPM	Watts	Amps	Therm Prot.
			S.P.	CFM		S.P.	CFM		S.P.	CFM						
DJ-3	3	69,000	.034	48	72,000	.047	36	58,000	.048	33	115	60	1550	35	.43	Imp. Prot.
	4	105,000	.042	72	109,000	.053	55	92,000	.057	48						
	5	111,000	.043	72	104,000	.052	52	74,000	.052	39						
	6	100,000	.041	68	34,000	.042	17	25,000	.035	13						
D-3	5	270,000	.063	190	330,000	.085	166	295,000	.092	163	115	60	1550	74	.96	Yes
	6	356,000	.073	246	377,000	.090	190	300,000	.093	169						
	7	360,000	.075	259	330,000	.085	166	230,000	.080	118						
	8	320,000	.068	217	222,000	.075	110	123,000	.065	65						
I	8	900,000	.125	590	1,200,000	.143	603	1,100,000	.147	566	115	60	1725	1/4 HP	5.4	Yes
	9	1,110,000	.135	765	1,330,000	.150	653	1,100,000	.148	566						
	10	1,250,000	.140	850	1,260,000	.145	615	840,000	.136	440						
	12	1,030,000	.128	710	710,000	.115	357	400,000	.100	211						
IL	9	1,460,000	.145	1010	1,970,000	.175	989	1,700,000	.180	900	115	60	1725	1/4 HP	5.4	Yes
	10	2,080,000	.170	1370	2,460,000	.185	1240	1,900,000	.180	1010						
	12	1,920,000	.160	1325	2,230,000	.182	1120	1,500,000	.170	789						
	14	1,840,000	.159	1270	1,470,000	.158	740	825,000	.135	453	115	60	1725	1/3 HP	6.0	Yes
	16	900,000	.120	620	650,000	.113	340	350,000	.095	184						
	18	650,000	.099	450	440,000	.095	220	200,000	.075	106						
XL	16	4,000,000	.250	2760	4,000,000	.260	2010	3,300,000	.230	1763	115 208 230	60	1725	3/4 HP	10.8 5.4 5.5	Yes
	18	3,900,000	.240	2650	3,250,000	.240	1660	2,100,000	.190	1103						
	20	2,800,000	.195	1935	2,100,000	.175	1079	1,200,000	.150	626						
	24	1,500,000	.150	1035	1,100,000	.125	527	503,000	.110	266						
HD	20	5,300,000	.290	3690	5,200,000	.270	2440	3,600,000	.240	1870	208 230 460	60	1725	2 HP	6.3 6.4 3.2	No
	24	3,500,000	.220	2415	3,750,000	.220	1660	2,900,000	.218	1550						

IMPORTANT: Vents/Chimneys utilizing In-Line Draft Inducers must be vertically terminated above the roof line. Do not use for side wall venting. Consult factory for proper side wall vent system options.

## Tjernlund Products also offers:

Auto-Draft variable & fixed speed Inducers for roof top or side wall venting. Reduce vent diameters by up to 50% and overcome convoluted vent layouts. Fan speed is automatically regulated based on a user set manifold/vent pressure, resulting in perfect draft and true energy savings. Virtually unlimited capacities.

Combustion Air In-Forcers provide dedicated combustion air for safer, more efficient equipment operation. Eliminates burner control lockouts & oil odors associated with backdrafting. Ideal for "confined space" and electric to oil or gas conversions. Residential and commercial fixed & variable speed capacities up to 6000 CFM available.

### Auto-Draft® Inducer

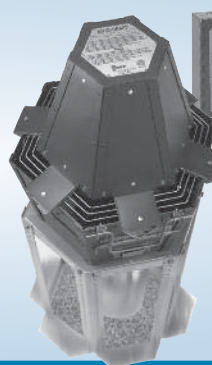

### Combustion Air In-Forcer™

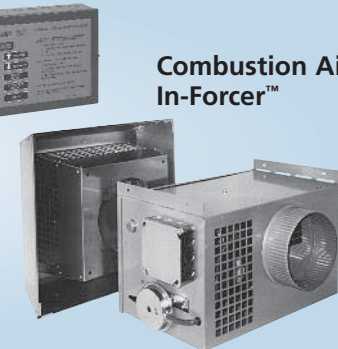

Distributed by:



**TJERNLUND PRODUCTS, INC.**

1601 Ninth Street White Bear Lake, MN 55110-6794  
 Phone: 651.426.2993 800.255.4208 Fax: 651.426.9547  
 Visit our web site: [www.tjernlund.com](http://www.tjernlund.com)

Copyright © 2003 Tjernlund Products, Inc. P/N 8500590 Rev B 4/03